

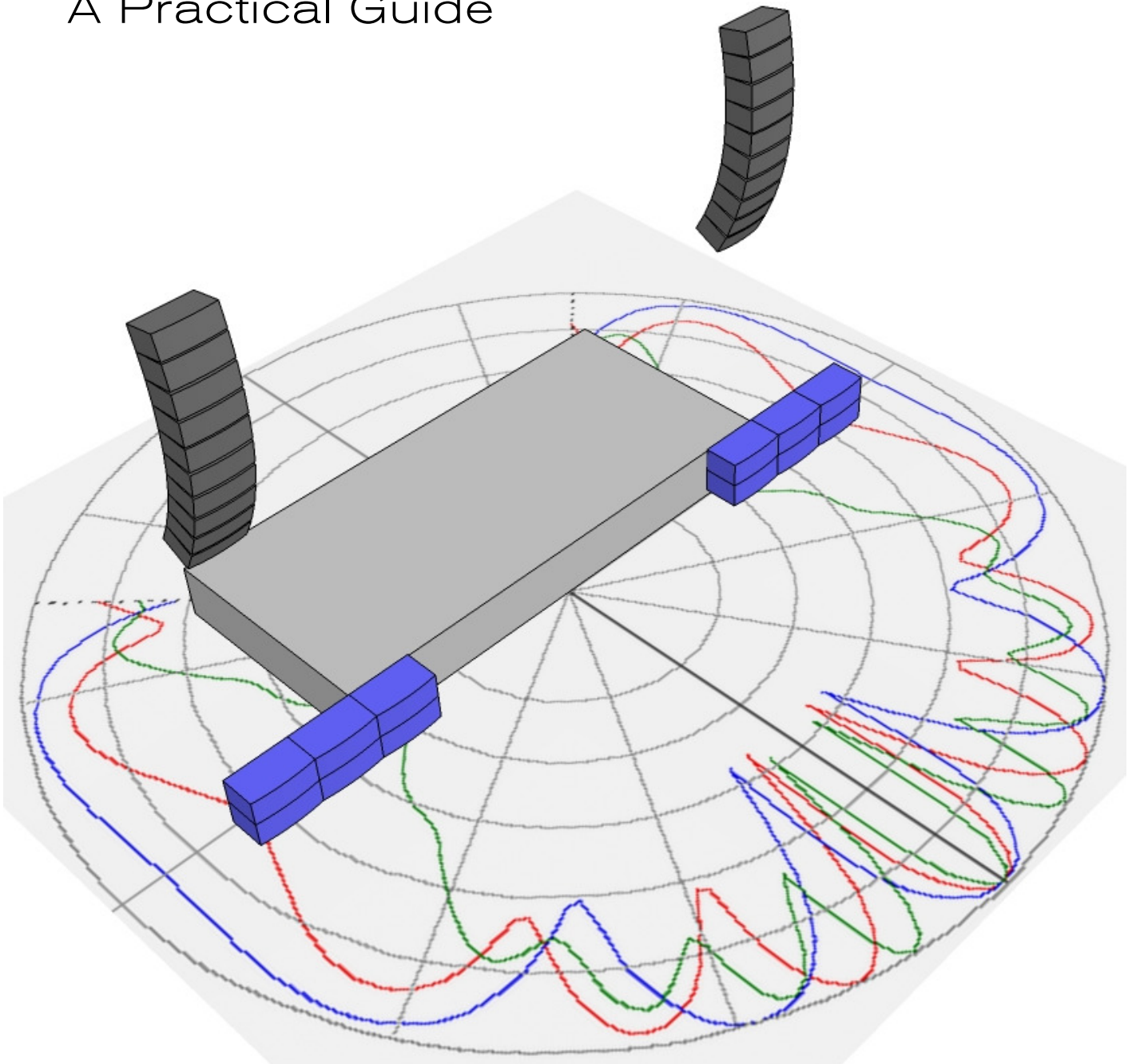

# Subwoofer Arrays

A Practical Guide



---

# Subwoofer Arrays

## A Practical Guide



Jeff Berryman

Rev. 1 / June 7, 2010

### TABLE OF CONTENTS

1. Introduction .....	1
2. Acoustical Concepts.....	2
2.1. Wavelength .....	2
2.2. Basic Directivity Rule .....	2
2.3. Horizontal-Vertical Independence.....	3
2.4. Multiple Sources and Lobing .....	3
2.5. Beamforming.....	5
3. Gain Shading .....	6
4. Graphs and Array Design Tools .....	6
5. Woofer Array Types .....	7
5.1. Broadside arrays .....	7
6. Groundstacked Arrays.....	10
7. Flown Arrays.....	13
8. Gradient Arrays .....	17
8.1. Example .....	17
8.2. Characteristics of Gradient Arrays.....	18
8.3. Advanced Gradient Drive.....	20
8.4. Gradient Line Arrays.....	21
8.5. Gradient Array Applications .....	23
8.6. Endfire arrays .....	25
Appendix A: Setting Up Subwoofer Crossovers .....	27
Appendix B: Subbass Equalization .....	30
Appendix C: Distortion Beaming.....	32

## 1. Introduction

In sound systems, it would be terrific if loudspeakers worked like spotlights: find the loudspeaker boxes with the right directional patterns, aim them where you want sound to go, and you're done. Of course, that's not the way it works, especially for bass.

Ordinary bass speakers are very nearly omnidirectional over their working ranges, but when you stack up a few of them, the pattern becomes more directional and more complex. Imagine if lights worked that way -- a bare light bulb would illuminate the whole room, but four of them in a row would only light up some parts of it.

To make things worse, when you use multiple woofer stacks -- stage left and stage right, for example -- you get wave interference (also called "comb filtering"), causing peaks and nulls in different places in the room at different frequencies. If light worked that way, then when you lit up a room with two white lights spaced some distance apart, the room would be illuminated with a rainbow of different colors.

Even beyond that, there's the problem of reverberation, which adds its own kinds of confusion and coloration in the time dimension. That effect that doesn't even have a parallel in lighting.

In the face of all these phenomena, how do we audio professionals design subwoofer arrays and drive schemes that provide required qualities of coverage and fidelity?

If we succeed, then:

- The bass will be clear and will have constant tonal balance over the entire listening area.
- The bass sound level will be in correct balance with the midrange and high-frequency over the entire listening area.
- Negative effects of reverberation and reflection will be minimized.
- Efficiency of the equipment (sound power output per unit cost) will be maximized.

This paper offers concepts and techniques for getting good bass. Our focus will be the frequency range from approximately 20 Hz to 150 Hz.

## 2. Acoustical Concepts

### 2.1. Wavelength

Just about everything having to do with loudspeaker array acoustics is relative to wavelength. A box or array is “large” if its dimensions -- or some of its dimensions -- are more than about 1.5 wavelengths across. A dimension is “small” if its dimensions are less than about a third of a wavelength.

Here are some typical wavelengths:

Frequency	Wavelength (feet)	Wavelength (meters)
20 Hz	55.8	17
50 Hz	22.3	6.8
80 Hz	13.9	4.3
120 Hz	9.3	2.8
200 Hz	5.6	1.7
1000 Hz	1.1	0.34
20000 Hz	0.0558 (= 0.67 inches)	0.017

For normal air temperature, pressure, and humidity, the formulas for wavelength are:

$$\text{Wavelength} = \frac{1116}{\text{frequency}} \text{ (feet)} = \frac{340}{\text{frequency}} \text{ (meters)}$$

### 2.2. Basic Directivity Rule

For ordinary sound sources, directivity is inversely related to dimension. If an object is small, its directivity is wide; if large, its directivity is narrow. See Figure 1.

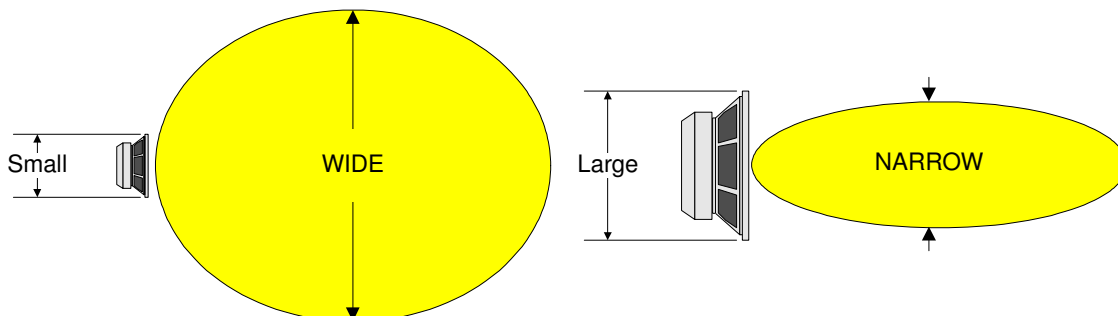

**Figure 1. Inverse relationship of size and directivity**

Remember that “small” and “large” are measured in wavelengths, not feet or meters.

### 2.3. Horizontal-Vertical Independence

The basic directivity rule applies *independently* in the horizontal and vertical planes. For example, a horizontal line of subwoofers might be large horizontally and small vertically. Therefore, its directivity would be narrow horizontally and wide vertically, as shown in Figure 2.

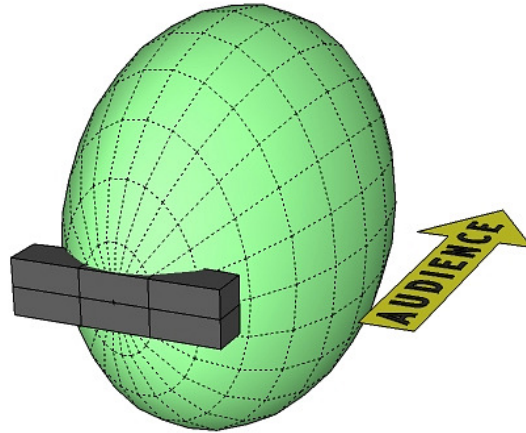

Figure 2. Asymmetrical pattern

### 2.4. Multiple Sources and Lobing

Many, if not most, subwoofer installations use two separate arrays on opposite sides of the stage. Sometimes these arrays are stacked on the floor, sometimes they're flown. Either way, the multiple sources exhibit what physicists call "wave interference", and what audio people call "comb filtering" or "lobing".

Figure 3 shows the directivity of a single EV Xsub woofer at 50 Hz. In this example, size of the stage is 40x20 feet. The red trace is the polar pattern. Circles are 6dB apart. The Xsub is essentially omnidirectional.

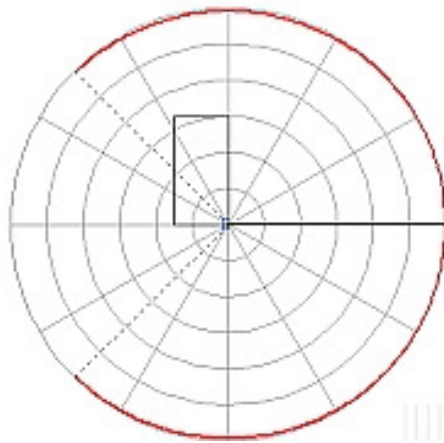
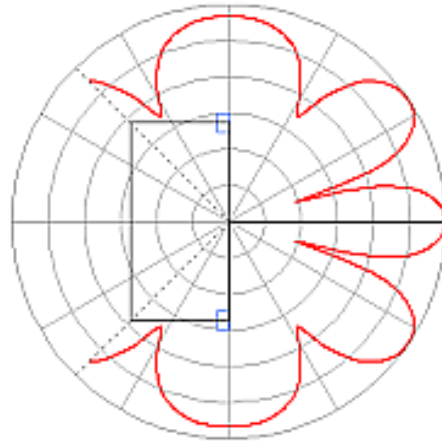

Figure 3. Single Xsub. 6dB / division.

Figure 4 shows what happens when another Xsub is added at the opposite side of the stage. The result is very different -- and not better!

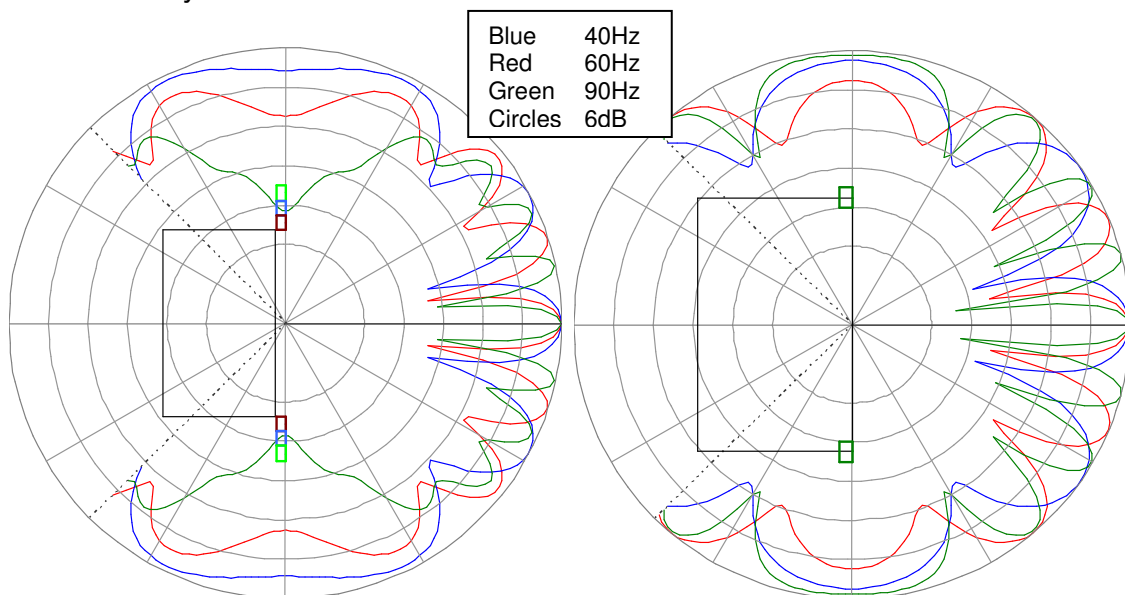

**Figure 4. Left and Right Xsubs. 6dB / division. 50Hz**

Since the woofers are omnidirectional, everyone in the room hears both woofers. However, the distance from each woofer to the listener is different, except in the middle. Where the distance difference equals an odd multiple of a half-wavelength, the sounds from the two woofers cancel, and the listener hears no bass, at least not directly from the woofers.

These lobes will produce uneven bass tonal balance and level in the venue. In indoor venues, the tonal balance problems are partly masked by reverberation, but the lack of clarity remains. Outdoors, there is no reverberation, and the problem is usually quite obvious.

Figure 5 shows performance of two practical cases - groundstacked rows of subwoofers, and flown subwoofer line arrays.



**Figure 5. Horizontal patterns of left-right stacked and flown subs.  
Left: Horizontal array, 3x Xsub per side. Right: Vertical (line) array, flown left-right.**

The only region that is lobe-free at all frequencies lies along a line running directly out from center stage. Along this line, the bass is strongest and clearest. This is the familiar “power alley” effect

that makes the bass sound very good at the mix position, but does not give the mix engineer a good idea of what the rest of the audience is hearing.

The best solution for lobing problems is to use a single center cluster instead of separate left-right stacks. This works for both horizontal and vertical arrays. However, it is not often a practical solution for staging and rigging reasons.

When left-right stacks are used, lobing problems can be reduced using stacking, beamforming and/or gradient woofers. In all cases, the idea is to minimize interference between the coverage areas of the two stacks.

## 2.5. Beamforming

Beamforming is a technique by which the sound wave emitted by a large array can be aimed and shaped. In a beamformed array, the loudspeakers are driven separately (or in small groups), and each drive signal has its own delay and level.

Figure 6 and Figure 7 illustrate a typical effect of beamforming on a typical medium-sized subwoofer array. The illustrated array is four EV Xsub subwoofers. Figure 6 shows the array with no beamforming. In Figure 7, the delay values are chosen to direct the bass radiation offstage. This is a typical technique for increasing side coverage.

Beamforming only works on arrays that are large (as defined above in Section 2.1). Controlling directivity of small arrays requires gradient techniques -- see Section 8.

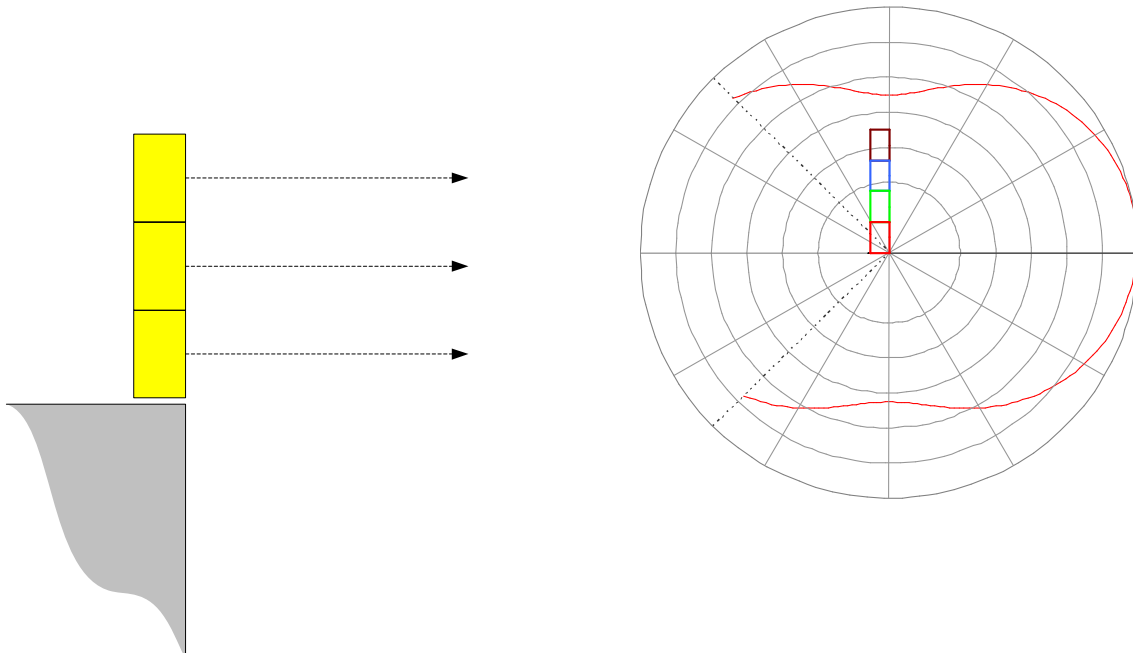

**Figure 6. Four EV Xsub woofers in a simple line.  
Plan view of one corner of stage. 60Hz. Audience on the right.**

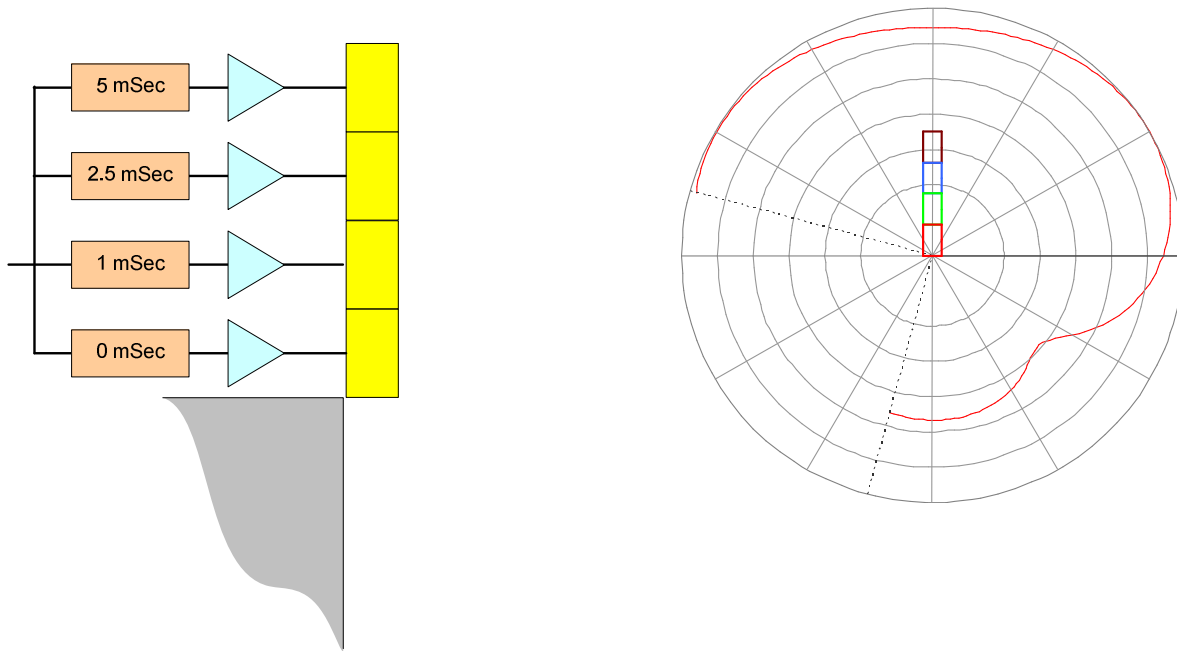

**Figure 7. Four EV Xsub woofers in a beamformed array.  
 Delay values (onstage to offstage): 0.0, 1.0, 2.5, 5.0 mSec.  
 Plan view of one corner of stage. 60Hz. Audience on the right.**

### 3. Gain Shading

The term “shading” means modifying array drive parameters for the elements on or near the ends of the array. “Gain shading” means adjusting -- specifically, reducing -- the drive gain for one or more elements at either end of an array.

For long arrays, shading takes the form of a gradual tapering of gain from 0 dB to about -6 dB over the last two or three elements at each end. The effect of the shading is to make the coverage pattern more regular and less frequency-dependent. For an example of this, see Figure 21.

### 4. Graphs and Array Design Tools

The polar patterns illustrated in this document have all been produced by the Electro-Voice program **LAPS 2.2A**. LAPS is EV’s line array design program. Starting with release 2.2A, LAPS includes a subbass pattern modeling page.

LAPS has a sister program named EVADA, short for “Expandable Vertical Array Design Assistant”, a streamlined version of LAPS for designing arrays of Electro-Voice EVA loudspeakers. EVADA has the same subbass modeling page as LAPS. LAPS and EVADA are Microsoft Excel applications that are free downloads from the EV website, [www.ElectroVoice.com](http://www.ElectroVoice.com). They require an IBM PC (or PC emulator environment), Microsoft Excel version 2000 or newer, and Windows 2000 or newer.



## 5. Woofer Array Types

In pro audio, we find three kinds of woofer arrays:

1. **Broadside Arrays**, in which a number of woofers are arranged in a row, and the primary radiation is at right angles to the row. This is the typical subwoofer arrangement seen in most applications, either stacked (horizontal row) or flown (vertical row). In current practice, broadside arrays are overwhelmingly the most common form.
2. **Gradient Arrays**, in which woofers are arranged and driven in specific ways to provide microphone-like directional patterns -- cardioid and hypercardioid, usually. Such arrays involve woofers with multiple drive channels that may contain delays, filters, and/or polarity inversions to achieve their results. Gradient arrays may be purchased as single enclosures, or can be constructed using separate woofer boxes.
3. **Endfire Arrays**, in which a number of woofer cabinets are arranged in a spaced row pointed in the desired direction of radiation, and driven in a successively delayed fashion so as to create a very narrow pattern. The endfire array is the loudspeaker equivalent of a shotgun microphone. Endfire arrays are rare, and are only useful in specific long-throw applications, outdoors or in huge venues.

### 5.1. Broadside arrays

A broadside array is a row of woofer boxes (or stacks of boxes) with the sound radiation more or less at right angles to the row. The row might be straight, curved, or staircased.

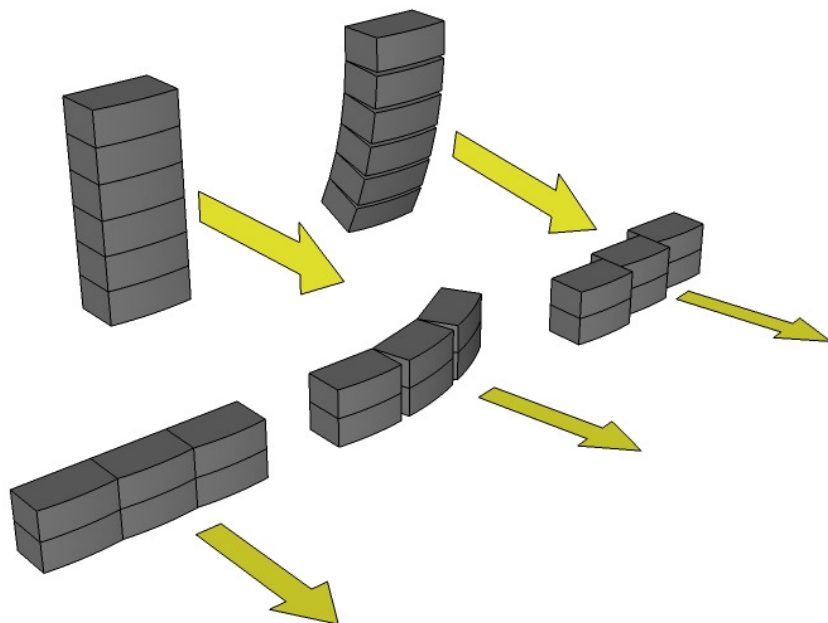
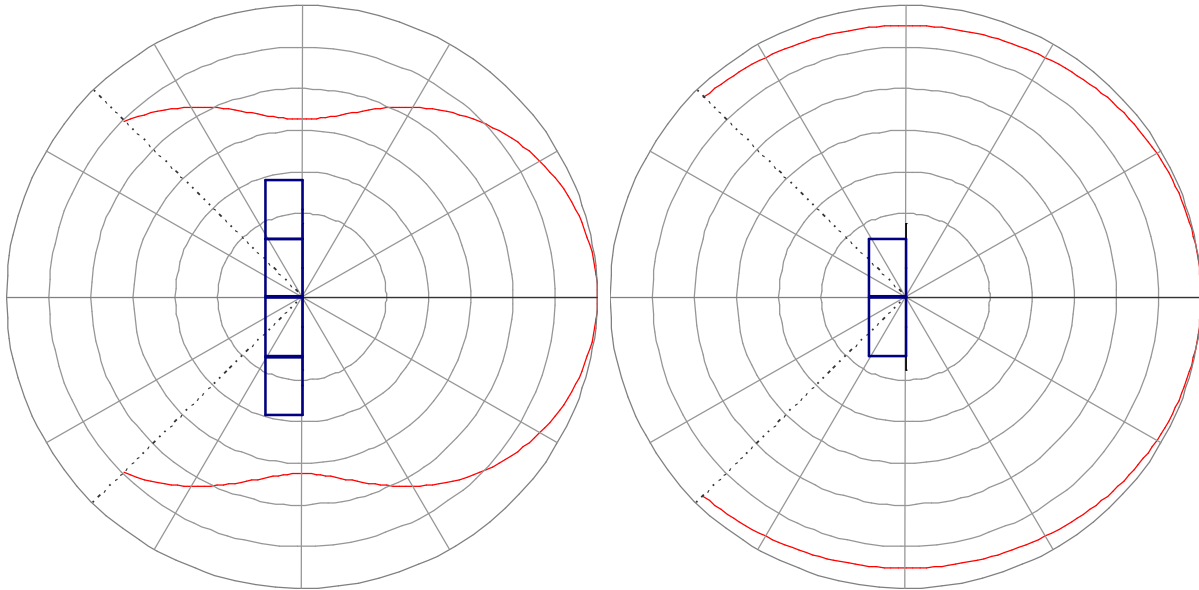

Figure 8. Broadside arrays

Broadside arrays are the most common woofer configurations, because they're easy to design and set up. However, getting good bass over a wide area requires some additions to the basic approach, as we shall see. Figure 9 through Figure 12 show some basic principles.

Figure 9 shows that long arrays have narrow patterns, while short arrays have wide patterns.



**Figure 9. Arrays, long and short. Two and four EV Xsub woofers. 60Hz. Plan view. Audience on the right.**

Figure 10 shows that straight arrays have patterns which become narrower and have more lobes with increasing frequency. Curved arrays, if long enough, have more constant directivity.

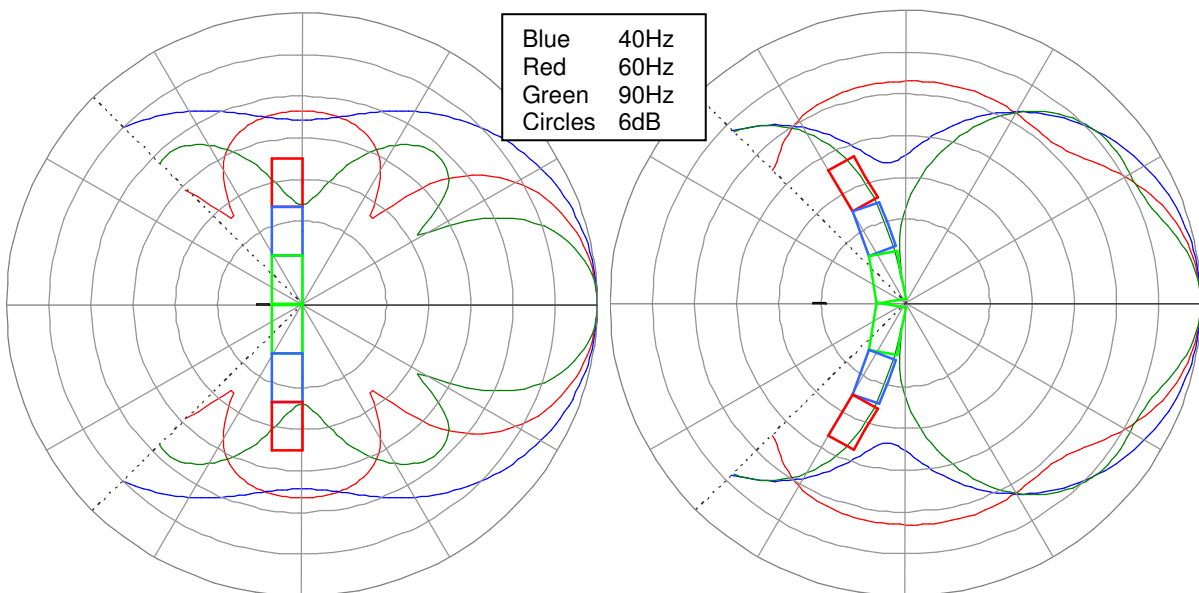

**Figure 10. Arrays, straight and curved. Six EV Xsub woofers. Audience on the right.**

Figure 11 shows that staircasing is essentially equivalent to tilting. Staircasing can be useful when staging and/or appearance considerations prevent the use of tilted arrays.

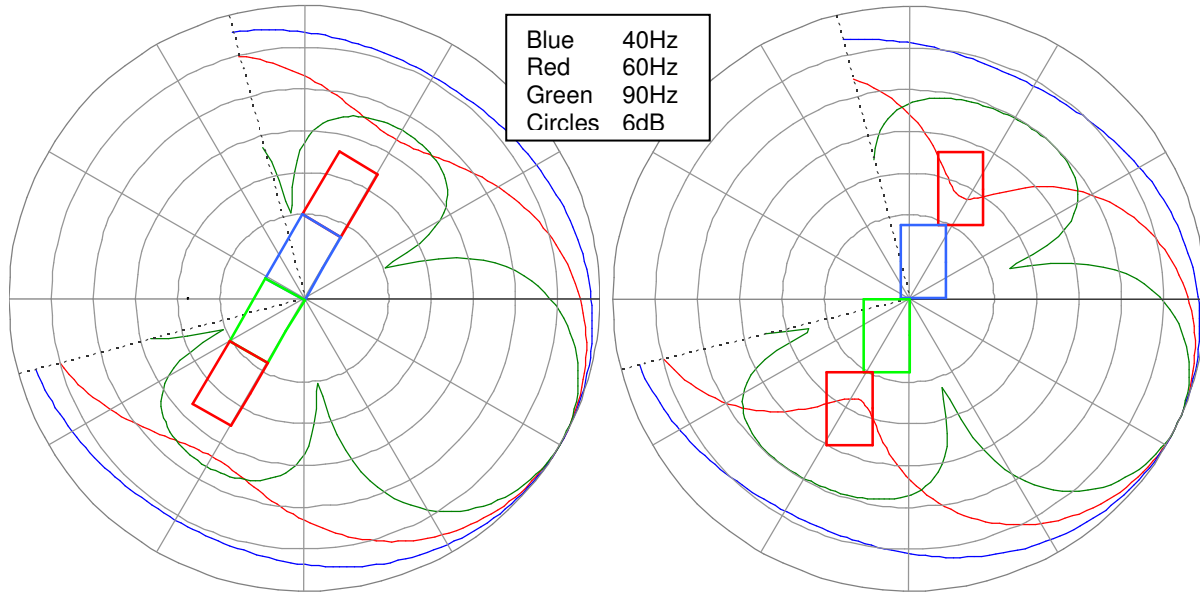

**Figure 11. Arrays, tilted and staircased. Four EV Xsub woofers. Audience on the right.**

Figure 12 shows that for pattern widening, staircasing can be used instead of curving. In this case, the staircased results are better.

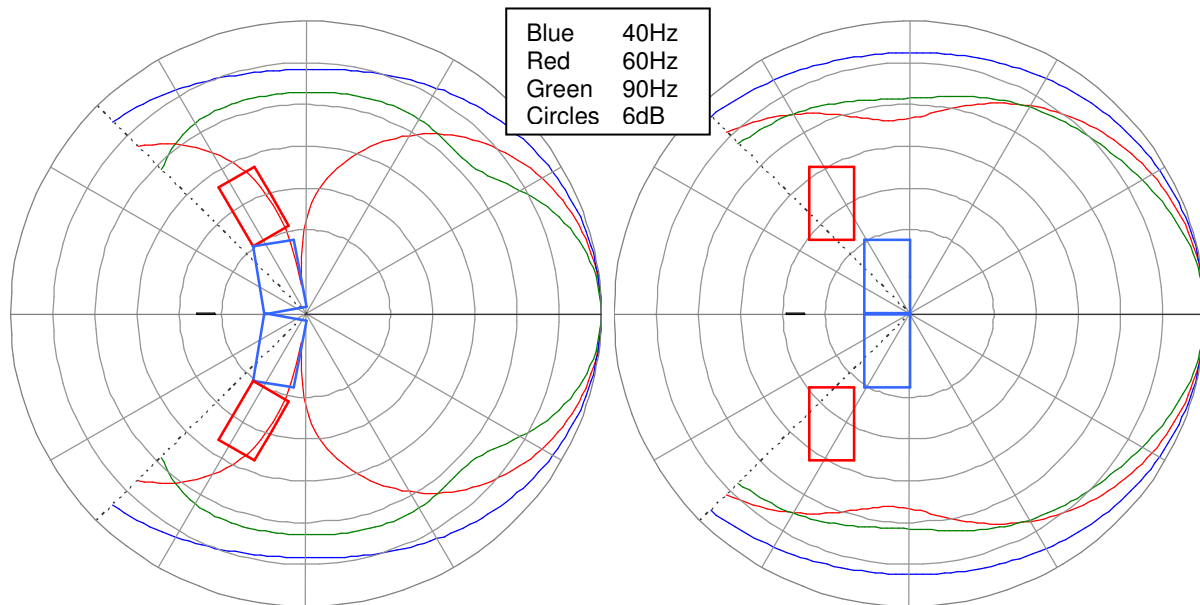

**Figure 12. Arrays, curved and staircase-curved. Four EV Xsub woofers. Audience on the right.**

## 6. Groundstacked Arrays

**Pattern Width.** For groundstacked horizontal arrays, width of coverage is often an issue. Straight-line subbass arrays wider than about 10 feet (3m) are too directional for most venues. For example, the graphs in Figure 9 show that the coverage pattern of an array of four EV Xsub woofers (approximately 12 feet, or 3.7m wide) is only 90° wide at 60Hz. At higher frequencies, it would be even narrower.

An even more severe example is shown in the left-hand diagram of Figure 10, an array of six Xsub woofers. Physical width of the array is approximately 24 feet (7.3m). This example shows that the pattern is only 60° wide at 60Hz, and highly frequency-dependent.

You can broaden and smooth the patterns by curving or staircasing the array (see Figure 12), or by using beamforming.

**Systems with Left-Right Arrays.** For systems with left-right arrays, it's good to understand the pattern of each individual array, but optimum design requires considering both arrays at once.

If we had perfect control of directivity, we would make the left array cover only audience left, and the right array cover only audience right. Since this is not possible, the patterns overlap, and lobing results. The system design challenge is to minimize the lobing while at the same time covering the whole audience.

When the arrays are wider than about 10 feet (3m), you can take advantage of their narrow patterns to reduce lobing. By aiming the left and right beams offstage, you can reduce pattern overlap in the center while widening overall coverage at the same time. Figure 13 illustrates this. In the right-hand diagram, the woofer arrays have been aimed offstage at a 30° angle. In the right-hand picture, the nulls are shallower and coverage at 90Hz is improved.

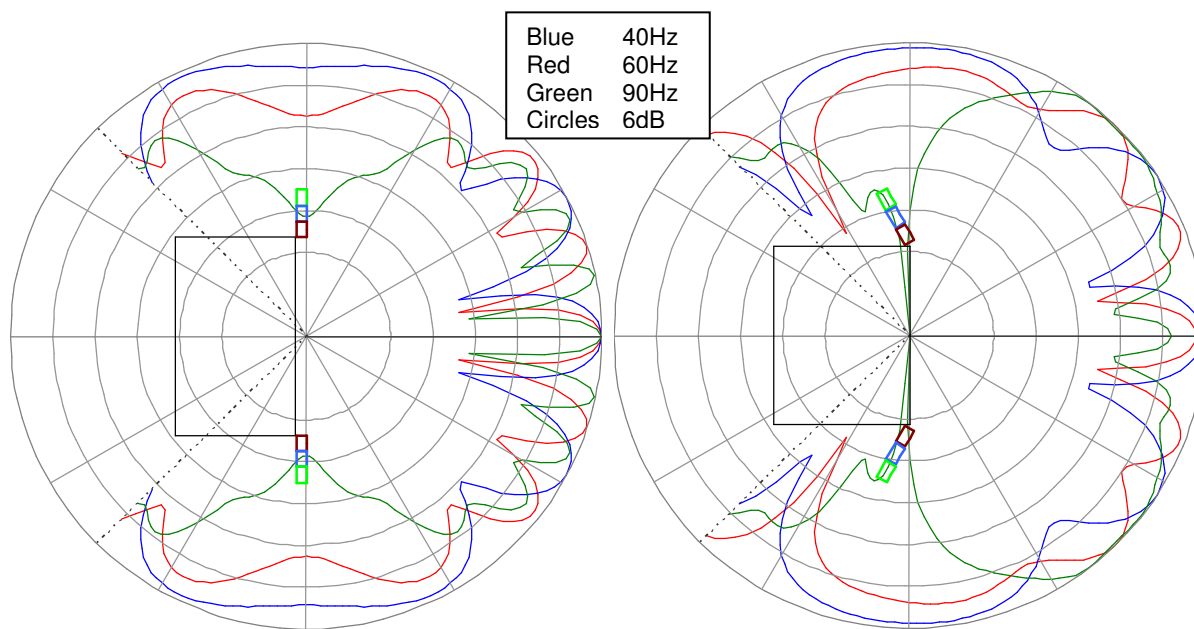

**Figure 13. Offstage aiming of groundstacked woofers.**  
Xsub x3 per side. Stage width 50 feet (15m). Plan view. Audience on the right.

Beamforming can have approximately the same effect as offstage aiming. Figure 14 illustrates the effect of applying beamforming delays to the array of Figure 13. The results are quite good.

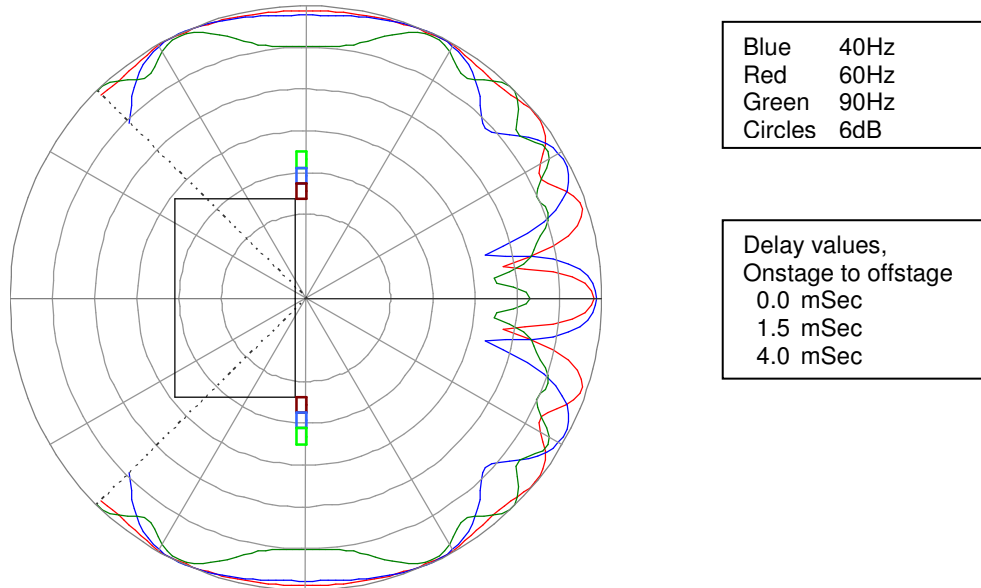

**Figure 14. Beamforming to create offstage aim.**  
**Xsub x3 per side. Stage width 50 feet (15m). Plan view. Audience on the right.**

**Large Central Stacks.** In large venues and for outdoor stages it is often convenient to stack subwoofers in a continuous line across the front of the stage. If beamforming delays are used with such clusters, the results can be excellent. Figure 15 shows the directivity of a row of 12 EV Xsub woofers with optimized delays.

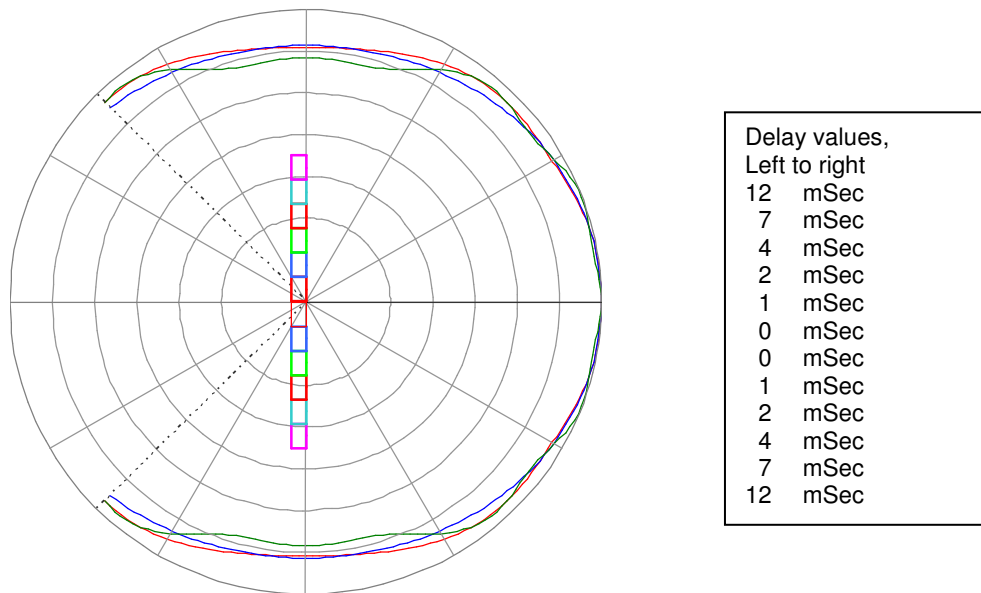

**Figure 15. 12 EV Xsub woofers in a centered row with beamforming.**  
**Plan view. Audience on the right.**

Figure 15 illustrates a subtle beamforming detail that's worth keeping in mind. If you look at the table of delay values, you'll notice that they're not in equal steps - the steps get progressively larger at the ends of the array. This is typical. When you do your own beamforming designs (using LAPS or some other modeling tool), you'll probably notice that larger delay steps at the ends of the array give better results in both aiming and beam-broadening applications.

Figure 16 shows the pattern of the same array as in Figure 15, but with no beamforming applied. The coverage angle is narrow and more frequency-dependent. Such arrays can be useful for covering long, narrow venues (parade routes, for instance), but for normal concerts the beamformed solution shown in Figure 15 would be preferred.

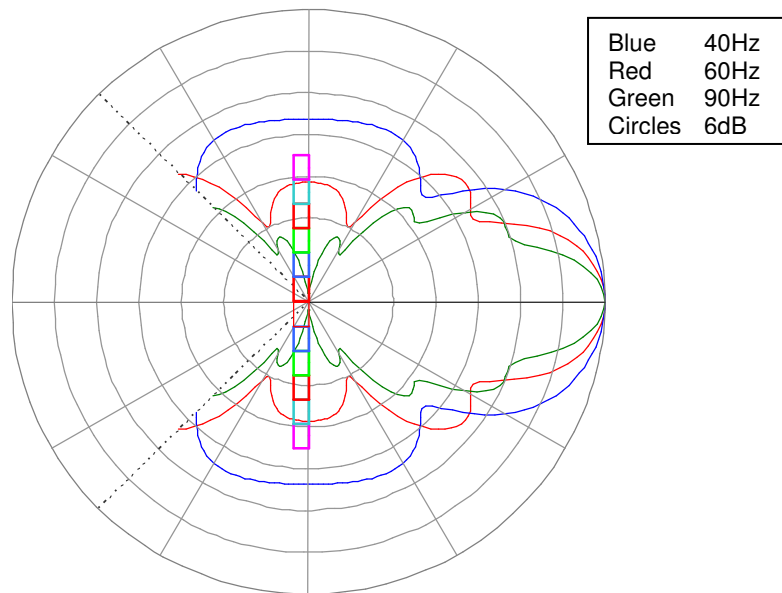

**Figure 16. 12 EV Xsub woofers in a centered row without beamforming. Plan view. Audience on the right.**

## 7. Flown Arrays

Flown subwoofer arrays are usually one box, or at most two boxes, wide. Thus, they have very broad horizontal coverage. At the same time, the arrays are usually long, which leads to vertical coverage that is often too narrow. In particular, there may be a lack of subbass in the first few rows of seats. Solutions are:

1. Curve the arrays in the vertical plane, as is shown for the horizontal case in Figure 10 and Figure 12. Curving is often visually desirable, in that it tends to align the face of the woofer stack with the face of the high-mid stack. However, it only works well for very tall stacks.
2. Add a few groundstacked woofers at center stage. Make them just loud enough to cover the affected area. Adjust the delay and level for even coverage over the front 10 to 20 rows. This is a common approach, but it's tricky to tune it for even coverage.
3. Use beamforming. This is usually the most effective technique for flown arrays.

Figure 17 through Figure 19 are results from the LAPS line array modeler that show a flown bass line array (eight EV XLC-215 woofers) in a typical two-balcony theater) with various solutions applied. The charts show vertical coverage patterns for one stack only, so they don't include any of the horizontal lobing effects that will be present, but they do give an idea of the vertical challenge.

Figure 17 shows a simple flown array with no curving, tilting, or beamforming. The bass problem in the front rows is evident.

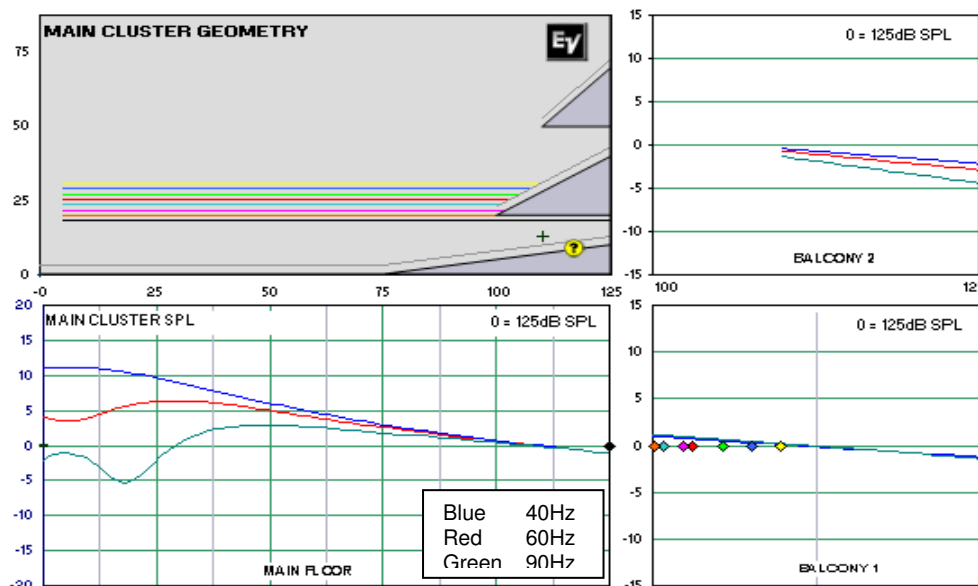

**Figure 17. No tilt, no beamforming.**

Figure 18 shows the same array as in Figure 17, but with two additional XLC-215 woofers stacked on or in front of the stage. The front-fill woofers are delayed by 2.0 mSec. The shape of the curves is quite sensitive to the delay value. Performance is better, but not excellent.

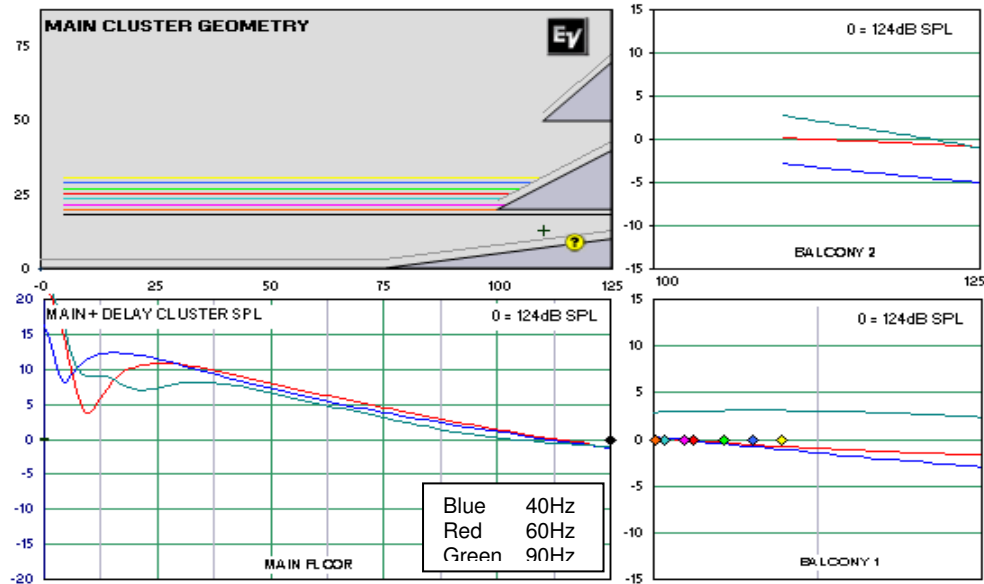

**Figure 18. No tilt, no beamforming.  
2x XLC-215 groundstacked front-fill woofers.**

Figure 19 shows how a bit of simple beamforming can give good results. The bottom two boxes in the stack are delayed by 4 mSec. No other processing is applied.

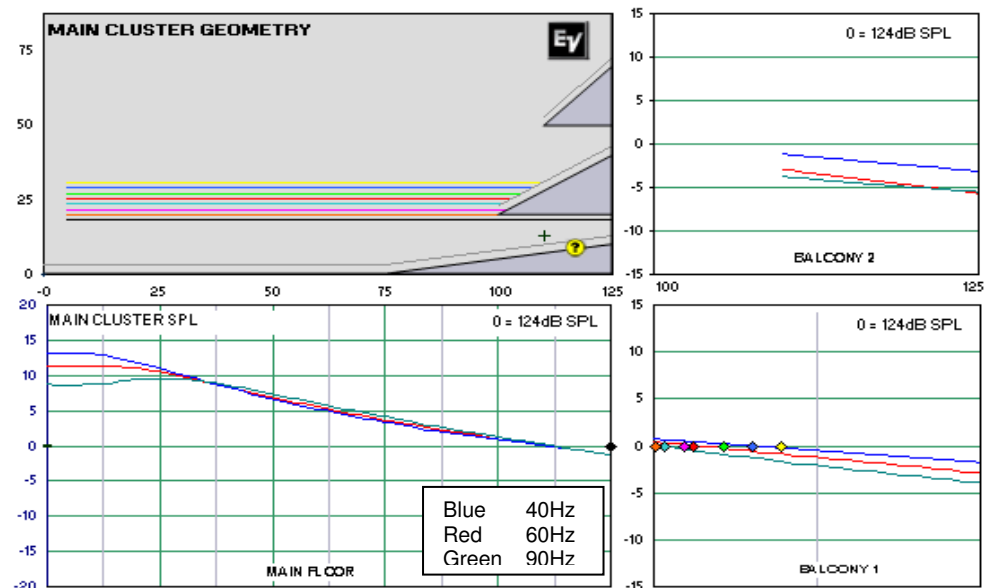

**Figure 19. Beamformed: bottom two boxes delayed 4.0 mSec**

In all of these scenarios, there is an overall bass level difference of 12-14dB from front to back. This will not be satisfactory for most applications. A perfect solution to the problem is difficult.

Where venue dimensions permit, high trim is the single most effective technique for evening out bass SPL from front to back. In the preceding illustrations, trim height was 32 feet (~10m) to top of stack. Figure 20 shows the same beamformed array as in Figure 19, but with a trim height of 65 feet (~20m) to top of stack. The level shift from front to back is much less.



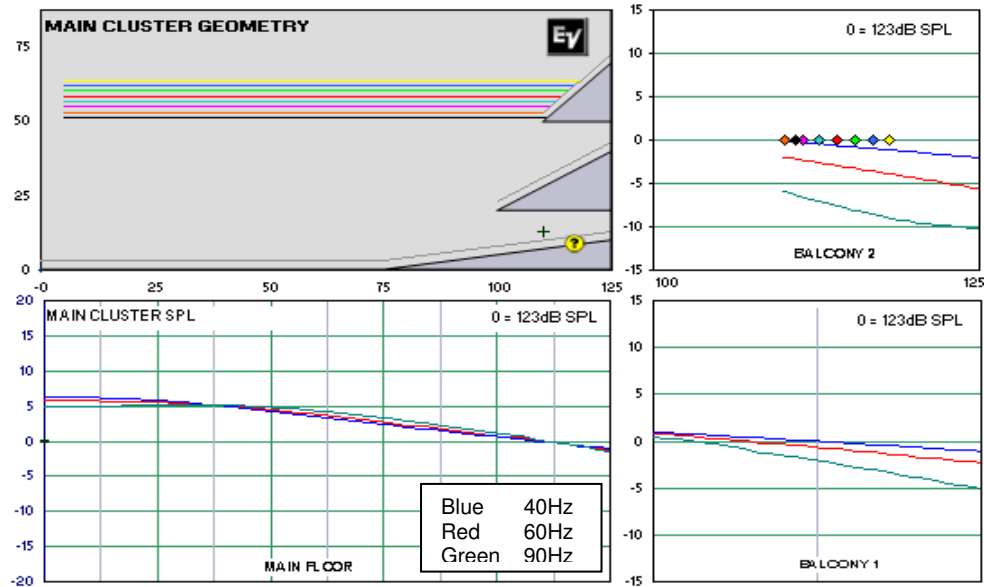

Figure 20. Beamformed; trim height 65ft (~20m).

**Flown Center Subbass Line Arrays.** Where staging and rigging considerations permit, a flown center stack of subwoofers can give excellent results. There is zero lobing, the horizontal coverage is essentially 360°, and the vertical coverage can be controlled well by beamforming.

Figure 21 shows the coverage of a flown center cluster of 12 EV Xsub woofers in an arena venue. The woofers are hung in a straight line, an optimized set of beamforming delays are applied. As well, level shading has been applied. The result is a subbass coverage pattern that maintains constant tonal balance over the entire listening area and

In this example, the delays have been applied in pairs. That is, each adjacent pair of woofers has a drive channel. This is more economical than having a separate drive and amplifier channel for each woofer. However, should a separate drive channel per woofer be available, even better coverage would be possible.

Blue	40Hz
Red	60Hz
Green	90Hz

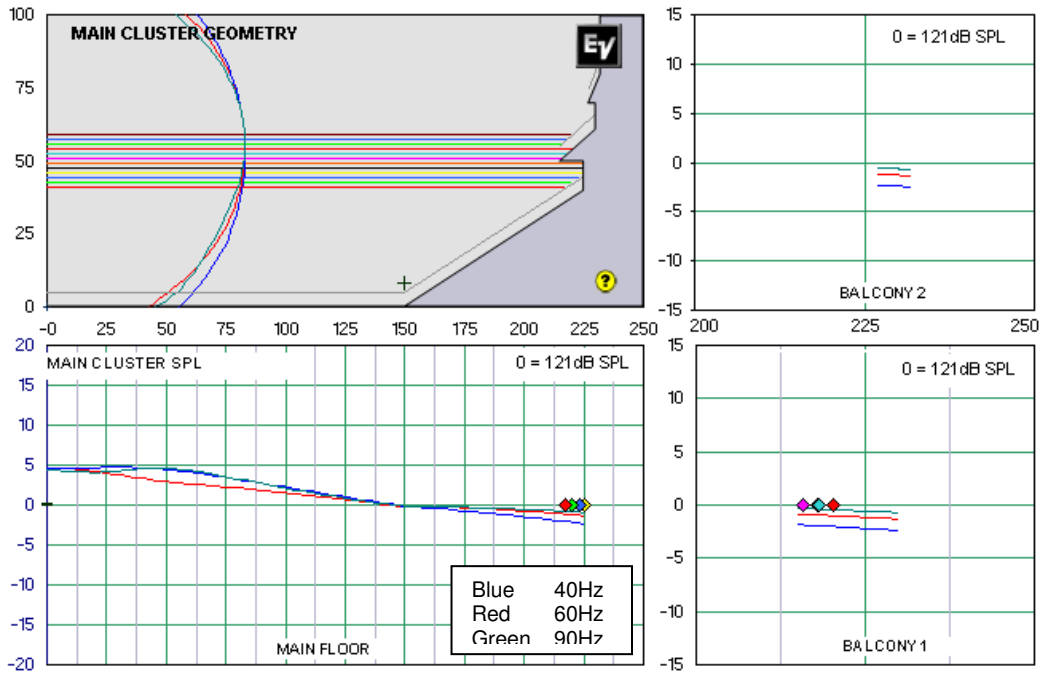

Figure 21. Xsub x12 center flow in arena.

Delay and Gain Top to Bottom	
5 mSec	-3 dB
5 mSec	3 dB
2 mSec	0 dB
2 mSec	0 dB
1 mSec	0 dB
1 mSec	0 dB
0 mSec	0 dB
0 mSec	0 dB
1 mSec	0 dB
1 mSec	0 dB
1 mSec	-3 dB

## 8. Gradient Arrays

A gradient array is an arrangement of loudspeakers driven at different amplitudes and phases in such a way as to cancel sound radiation in unwanted directions.

Gradient arrays only work when their dimensions are small with respect to wavelength. They are the opposite of beamformed and endfire arrays, which must be large in order to work. The reason for this is that gradient loudspeakers work by controlling pressure differences between the different parts of the sound wave, and must therefore be small enough to work “within” the wave.

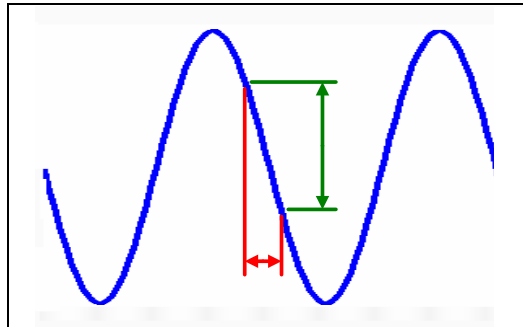

**Figure 22. Gradient**

Gradient loudspeakers are the loudspeaker counterparts of ordinary directional microphones, which work by picking up pressure differences between different parts of the sound wave.

The gradient technique is the only practical way to implement subbass pattern control with small arrays. When set up carefully and correctly, gradient arrays can provide a range of useful patterns that will give significantly better bass coverage than could be achieved using simple arrays of comparable size.

### 8.1. Example

Figure 23 shows a pair of EV Xsub subwoofers in a basic gradient configuration. Each loudspeaker box has its own drive. The boxes are positioned back to back, 4" (10cm) apart. The rear box is driven in reverse polarity and is delayed by 4.65 mSec. The resulting array has a cardioid directional pattern.

Although in this example the loudspeakers are mounted back to back, it need not always be so. As long as there is enough space between front and rear cabinets to allow the rear loudspeaker's sound to emerge, the rear cabinet can be mounted facing forward or backward. The gap should be at least 18 inches (50cm). In all cases, the delay value must always be adjusted to match the spacing between loudspeaker cones.

If each Xsub shown in Figure 23 were a column of Xsubs instead of a single Xsub, we would have a *gradient line array*. Gradient line arrays have useful properties and will be discussed further below.

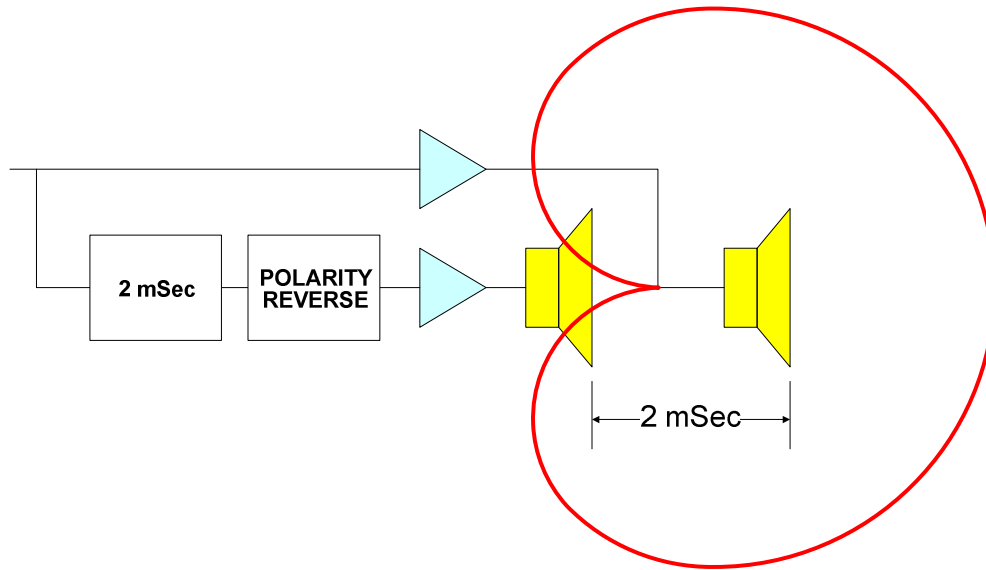
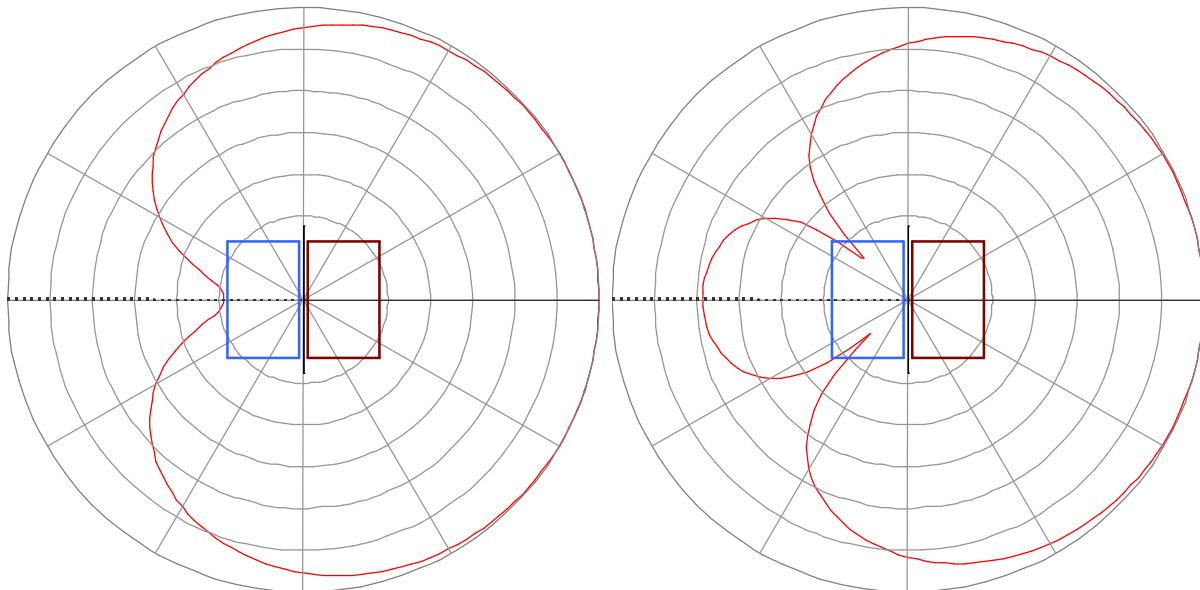

**Figure 23. Cardioid Xsub Pair**

## 8.2. Characteristics of Gradient Arrays

**Pattern Options.** For a given gradient pair, the pattern can be varied by changing the rear-element delay. Available patterns are similar to those of microphones: cardioid, hypercardioid (various types), and figure-8.

Figure 24 and Figure 25 show four pattern options for the back-to-back Xsub pair from the example above.



**Figure 24. Left: Cardioid. Delay = 4.65 mSec.  
Right: Hypercardioid,  $\pm 135^\circ$  nulls. Delay = 3.4 mSec.  
60Hz. Audience on the right.**

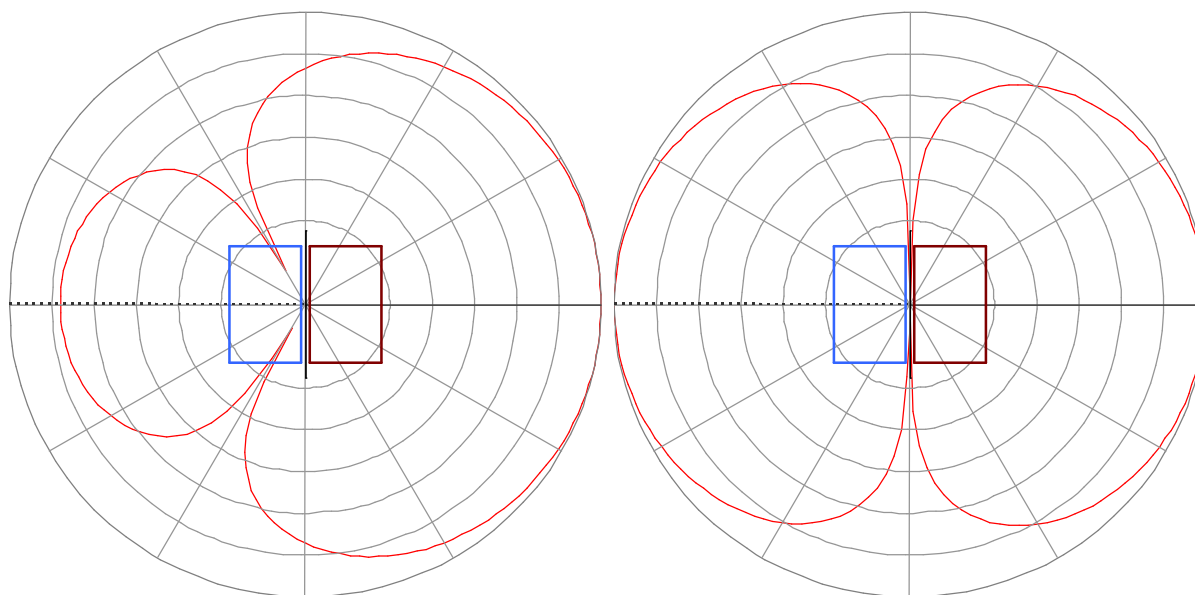

**Figure 25. Left: Hypercardioid,  $\pm 120^\circ$  nulls. Delay = 2.3 mSec.  
Right: Figure-8. Delay = 0.0 mSec.  
60 Hz. Audience on the right.**

**Element Spacing, Output, and Bandwidth.** When constructing a gradient pair, it is important to understand the role of element spacing. By “element spacing”, we mean the distance between front and rear loudspeaker cones. Larger element spacing increases subbass output, but decreases maximum operating frequency. Smaller element spacing decreases output but increases maximum operating frequency.

In our example, the element spacing is 62 inches (157 cm), which gives a maximum operating frequency of approximately 90 Hz. The pattern deteriorates rapidly above the high-frequency limit, as Figure 26 shows.

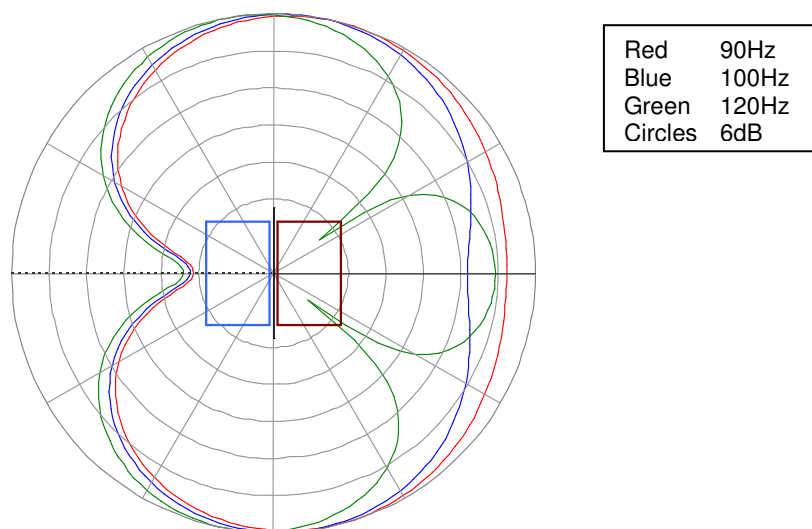

**Figure 26. Back to back Xsubs at 90Hz, 100Hz, and 120Hz.  
Audience on the right.**

**Effect of Nearby Surfaces.** Gradient pairs do not function correctly when they are situated in front of walls or other reflecting surfaces. Figure 27 shows what happens when our Xsub pair is placed two feet (60cm) in front of a wall. The wall is shown by the vertical line in the center of the graph. The two woofer boxes on the left are virtual boxes -- acoustic images created by the reflection in the wall. The two boxes on the right are the actual woofers.

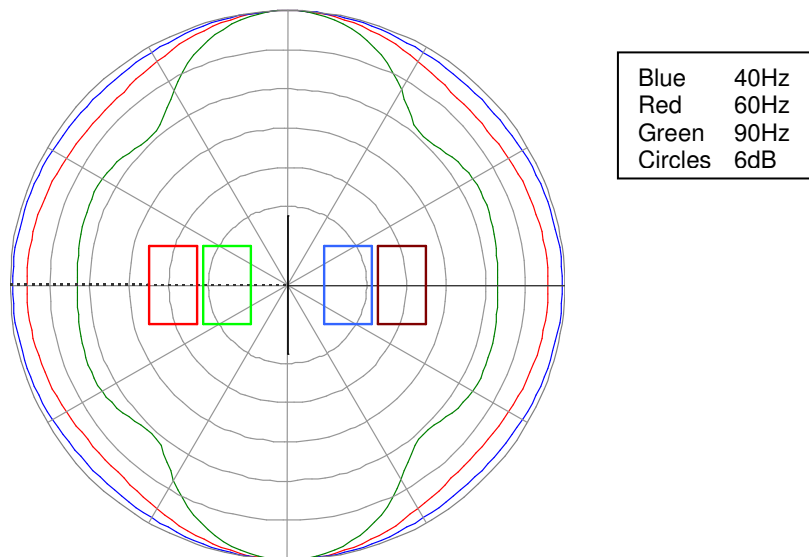

**Figure 27. Cardioid pair two feet in front of a wall.**  
**Left-hand boxes are acoustic images of actual array, which is on the right.**  
**Audience on the right.**

**Reverberant Field Tonal Balance.** Most subwoofer arrays become less directional at lower frequencies. Thus, as the frequency goes down, they send proportionately more of their output into the reverberant field of the venue. This causes an excess of subbass (sometimes called “bass bloom”) in the reverberant field.

Unlike almost all other kinds of loudspeakers, gradient loudspeakers maintain pattern control down to the lowest frequencies. Thus, they can be helpful in applications where a full subbass experience is needed, but without too much reverberant low-frequency energy.

**Element Drive Level and Woofer Count.** In practical gradient arrays, it has been found that minimum rear radiation occurs when the output of the rear element (it is often called the “steering element”) is approximately 6dB less than that of the front element. This result is due to cabinet shape effects. In practical terms, this means that the number of rear woofers can be half of the number of front woofers.

### 8.3. Advanced Gradient Drive

Using delays to create directional patterns is an effective technique at low frequencies, but it does not take into account the effects of loudspeaker cabinet shapes on the sound waves. The result is

that at the upper end of an array's frequency range, its radiation pattern can deviate from the expected shape.

When front and rear loudspeakers are combined in a single cabinet, such as in EV's XCS-312 cardioid subwoofer, it is possible to develop advanced drive processing methods that correct for these effects, so the loudspeaker maintains its specified directivity over its entire frequency range. These drive systems use frequency-dependent delays (also called "all-pass filters") to offset the effects of sound propagation around the cabinets.

#### 8.4. Gradient Line Arrays

When gradient pairs are assembled into a line array, the resulting directivity exhibits both gradient and broadside characteristics.

Figure 28 shows the radiation pattern of a gradient line array that is only two boxes tall, which is too short to exhibit broadside array behavior. The pattern is a simple cardioid of rotation.

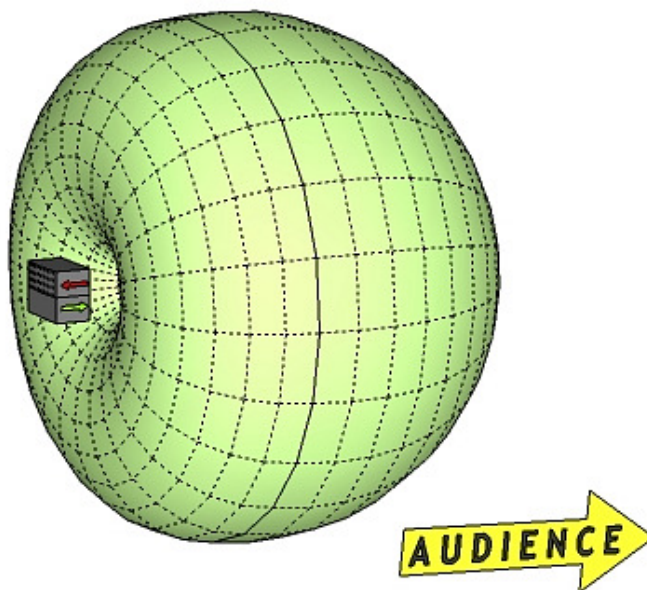

**Figure 28. Very short gradient line array.**

Figure 29 shows the pattern of a gradient line array that is long enough to exhibit broadside behavior. Its pattern is a flattened cardioid of rotation.

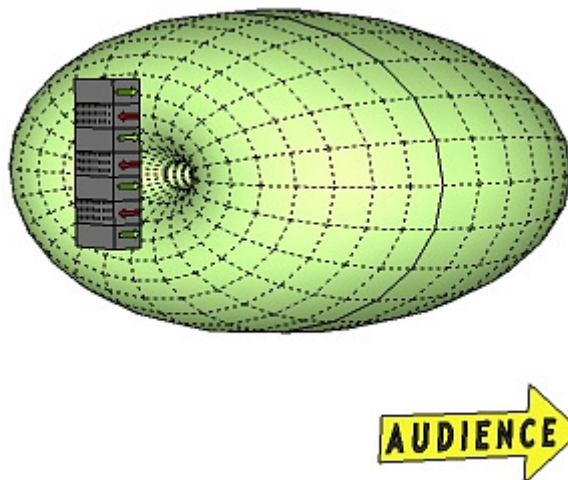
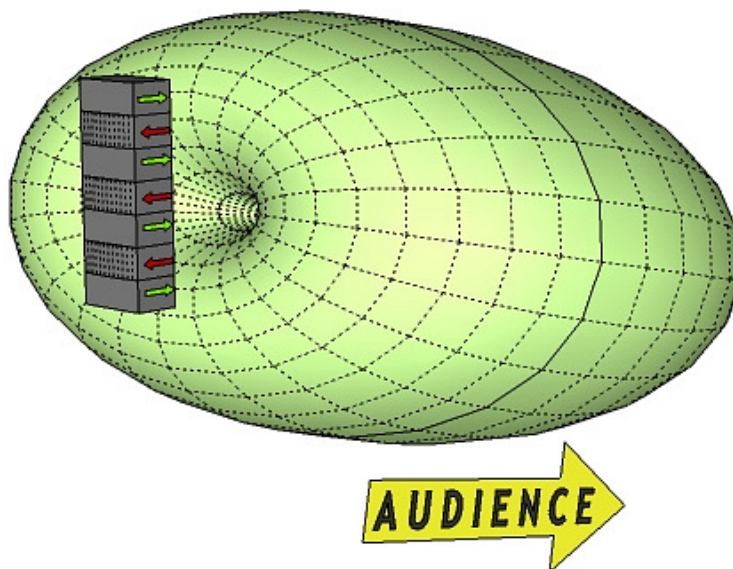

**Figure 29. Longer gradient line array.**

In practice, gradient line arrays can be constructed from purpose-built gradient loudspeakers such as the EV XCS-312 subwoofer, or from two columns of conventional loudspeakers, stacked or flown one behind the other.

**Beamformed Gradient Line Arrays.** Beamforming delays can be applied to a gradient line array to tilt its pattern. The beamforming delays must be applied equally to front and rear elements of each gradient pair in the array.

Figure 30 shows a the pattern of a gradient line array with added beamforming delay to create downtilt. The pattern could be described as a flattened, tilted cardioid of rotation. With advanced delay profiles, more complex vertical pattern shapes can be realized.



**Figure 30. Beamformed gradient line array.**



## 8.5. Gradient Array Applications

As noted above, gradient arraying is useful for small subwoofer arrays and for line arrays which, while large in the vertical dimension, are small in the horizontal.

The problems of small arrays fall into two categories:

1. Lobing, due to overlap between left and right stacks.
2. Excessively wide coverage.

As well, gradient arrays are useful in cases where rearward bass radiation is a problem. The most common issues are:

- a. Too much bass on stage.
- b. Undesirable rearward radiation from delay clusters.

**Left-Right Arrays.** For a stacked or flown left-right subwoofer system, using gradient arrays pointed offstage helps reduce lobing. Figure 31 compares the coverage of a single-wide Xsub stack on either side of the stage with that of a gradient configuration of the same size.

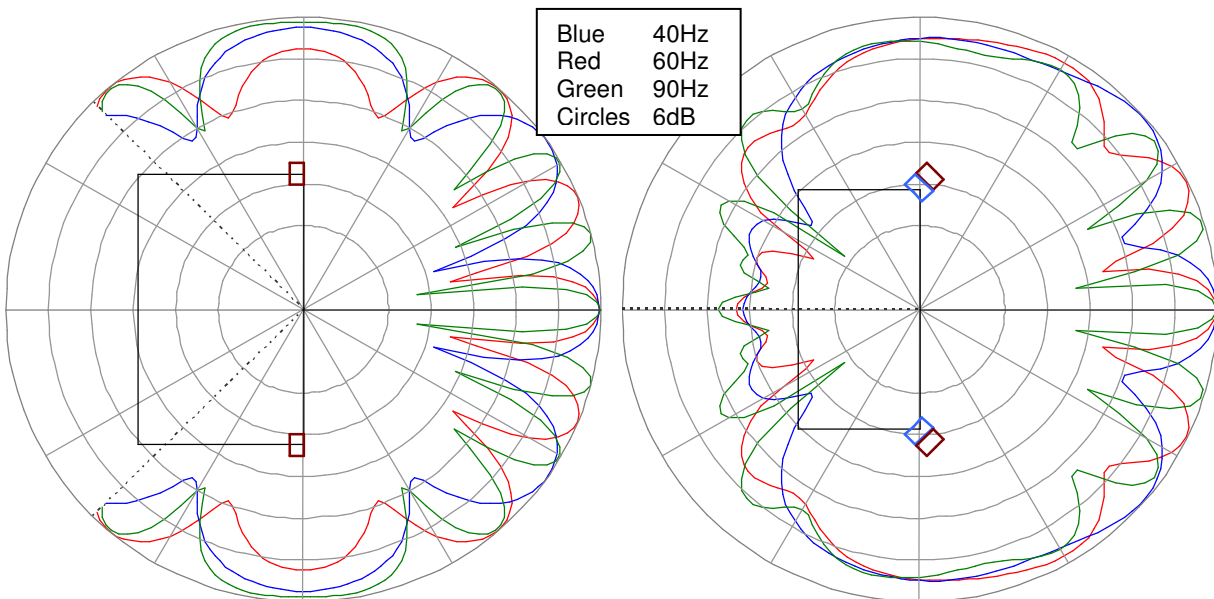

**Figure 31. Simple vs. gradient left-right solutions. Stage width=50' (15m).  
Left: Two Xsubs stacked left-right, simple drive.  
Right: Two 135° hypercardioid gradient woofers aimed 45° offstage.  
Plan views.**

**Bass on Stage.** Although Figure 31 doesn't show it, the angled-hypercardioid configuration puts a good deal less bass onto the stage than the simple one.

For the simple configuration on the left, performers at center stage hear the summed output of both subbass stacks from a relatively short distance away. Nowhere in the venue is the subbass louder than this.

For the right-hand configuration, however, the gradient woofers' hypercardioid nulls are pointed directly across the front of the stage. In typical configurations, this reduces the subbass level at downstage center by 15dB or more.

**Coverage Control for Smaller Arrays.** For small venues with flat floors, stacked subwoofers usually create excessive bass levels in the audience areas near the stage. While this might be fine for a dance club, it is not fine for a corporate AV presentation. In such cases, using a small center-flown subwoofer can provide excellent coverage without excessive levels anywhere. However, if a conventional woofer is used, it will be essentially omnidirectional, which means that (a) large amounts of bass energy will be radiated into the reverberant field, which will make for muddy sound, and (b) the bass on stage will be quite loud.

In contrast, hanging a cardioid or hypercardioid woofer above the stage will put the bass energy where it's needed -- in the audience -- and keep it out of the reverberant field and away from the stage.

Figure 32 shows a 120° hypercardioid woofer. If you think of the diagram as a horizontal polar plot, you'll see that it puts most of the bass energy out front and not into useless directions. If you think of it as a vertical plot, you'll see that the hypercardioid null points at the stage.

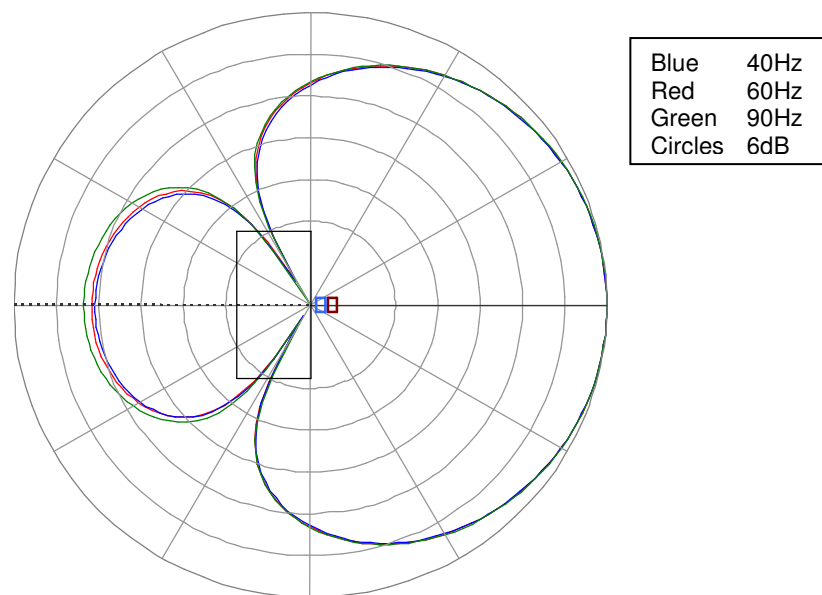

**Figure 32. Small 120° hypercardioid woofer above center stage.  
Plan view AND side view.**

**Large Central Clusters.** Although large central woofer line arrays tend to provide excellent sound on their own, they can still benefit from gradient techniques in shows that do not require 360° subbass coverage. In such shows, implementing the woofer cluster as a gradient line array means that less bass energy is radiated into the reverberant field. The result is a clearer subbass experience, with more definition, impact, and sense of pitch.

According to acoustic theory, using gradient woofers will reduce reverberant subbass energy by 4 to 6 dB, compared to omnidirectional woofers.

**Delay Clusters.** In large venues, especially outdoor stadiums and fields, the use of delay clusters is common for augmenting sound level and quality in the more distant listening positions. The primary purpose of these clusters is to boost high-frequency level, to offset the air's relatively high absorption of high-frequency energy. However, it is sometimes necessary for the delay clusters to provide additional low-frequency energy as well. In these cases, conventional loudspeakers pose a problem. At low frequencies, normal delay clusters will be essentially omnidirectional; thus, they will radiate a considerable amount of sound back toward the stage. This rear radiation will be radically out of time synchronization with the direct sound from the main loudspeaker system, and detrimental interference will occur.

The solution for this problem is to use gradient loudspeakers for low-frequency delays. The pattern of choice in this case is the cardioid, since it has the lowest level of rearward radiation.

### 8.6. Endfire arrays

An endfire array is a row of boxes aligned on a common axis and driven so that the primary sound radiation is in the direction of the axis.

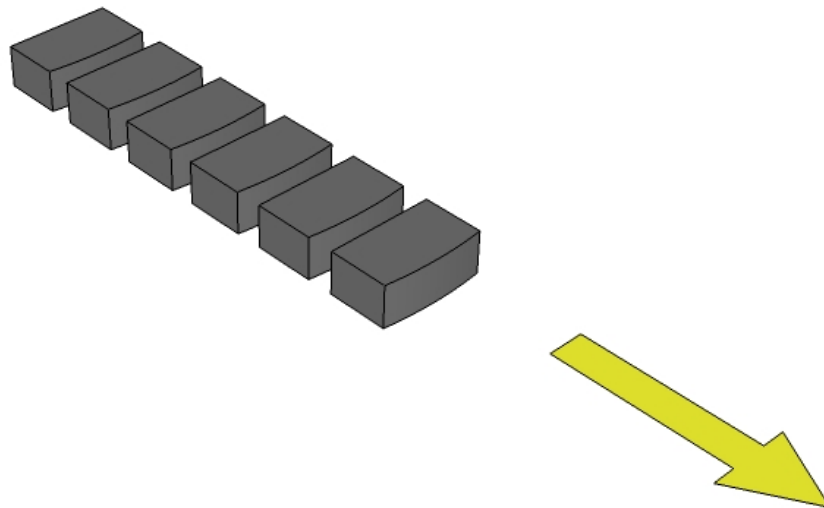

**Figure 33. Endfire array.**

Each box is driven from a separate delay. All the boxes are in the same polarity. In the simplest case, the boxes are equally spaced and the interbox delay time is equal to the time that a sound wave takes to get from one box to the next. Figure 34 shows performance of an example.

In the graphs used here, maximum output is arbitrarily shown as 0dB. In fact, with long endfire arrays, it is possible to project powerful, directional bass over long distances.

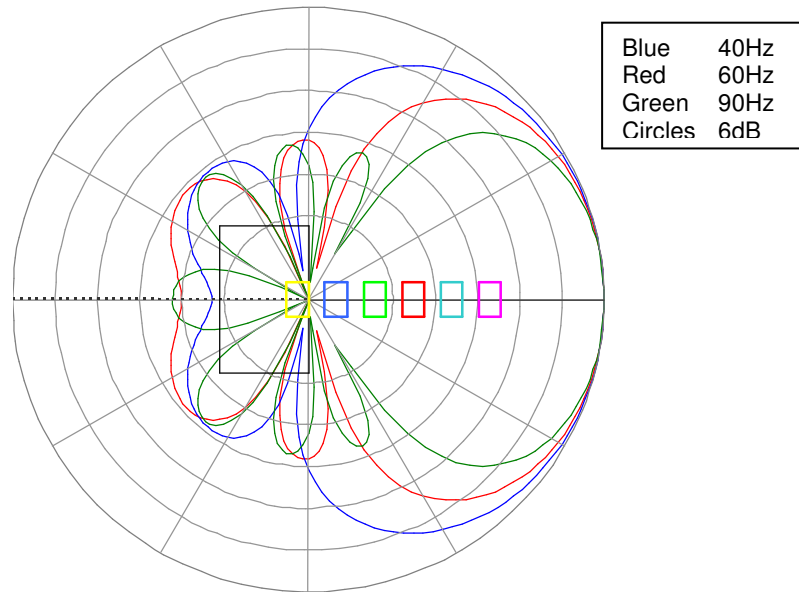

**Figure 34. Endfire array. EV Xsub x 6.  
Interbox spacing 2 feet (60cm). Interbox delay 4 mSec.**

## Appendix A: Setting Up Subwoofer Crossovers

*Setting up subwoofer crossovers is not really a subwoofer arraying issue. However, crossover tuning is a critical factor for subbass sound. The following procedure is adapted from the EV document **FIR.1: Getting Started**, distributed with EV's FIR.1 FIR-drive crossover software for the N8000 Matrix Processor.*

Your task is to set up the frequency, type, delay, polarity, and gain parameters for the main (Himid) cluster and the subwoofers. That may sound difficult and tedious, but it's actually not too challenging if you follow a defined procedure. There are numerous procedures for tuning subwoofer crossovers. The procedure given here will provide good results in most indoor and outdoor situations.

The following is a basic procedure that will yield acceptable results in many situations.

1. Locate an audio signal generator or test CD capable of generating sine-wave tones in the frequency range around the subbass crossover frequency. Configure the system so that the tones may be directed through the main system, the subwoofers, or both.
2. If you have a standard left-right system, setup your signal paths so that only one side of the system is active. If you are using a single center subwoofer cluster (flown or stacked), set your signal paths to use both left and right main clusters.
3. Set initial crossover parameters as follows:

	MAIN ARRAY	SUBWOOFERS
<b>Frequency</b>	X-Line: 80 Hz XLC DVX 80 Hz XLC other 90 Hz XLD 100 Hz XLE 100 Hz	same as Main
<b>Type</b>	See below	18 dB/octave Butterworth OR 24 dB/Octave Linkwitz/Riley - see below
<b>Delay</b>	0.0 mS	0.0 mS
<b>Polarity</b>	Normal	18 dB/octave Butterworth: Inverted 24 dB/Octave Linkwitz/Riley: Normal
<b>Gain</b>	0.0 dB	0.0 dB

For the crossover type, you have two choices:

- **18 dB/octave Butterworth.** This type is good for configurations where the subwoofers are relatively distant from the main stacks (e.g. flown mains / stacked subs), and is good for reverberant environments. It is also relatively tolerant of misalignment.

- **24 dB/octave Linkwitz/Riley.** This type gives good results when the woofers are near the main stacks (e.g. flown mains / flown left-right subs) and the environment is not too reverberant. It is also good in situations where the main stacks need to work hard in the midbass. It requires more careful alignment to give clear, non-boomy sound.

Whichever type you choose, use the same type for both main and subwoofers.

4. Set the generator frequency to the crossover frequency you entered above. Set the level to a low value (-30 or less) and selectively unmute the system. Adjust the level of the tone so that it is clearly above the background noise level in the venue.
5. Mute the subwoofers and set the generator frequency to a value that's approximately double the crossover frequency. Using an SPL meter or PC measurement system such as SysTune<sup>®</sup>, measure the level.

If you do not have any measurement instruments, you can use a microphone with good bass response in conjunction with the mixing console level meter, or, failing that, your ears. Do not use a hand-held vocal microphone in this step -- its bass response will not be flat enough.

6. Mute the main array(s) and set the generator frequency to a value that's approximately 2/3 the crossover frequency. Unmute the subwoofers and adjust the subwoofer level to be the same as the main level measured in step 3.

After these steps, the main and subwoofer channels should have approximately equal overall acoustic gain. This is what will give the smoothest crossover. **If the program requires a subbass boost or cut, do not adjust the subwoofer gain.** Use equalization instead. Subwoofer equalization is discussed in Appendix B.

7. Estimate the difference in distance from your listening point to the main and subwoofer arrays. Referring to Figure 12, this will be  $D(LF) - D(SB)$ .

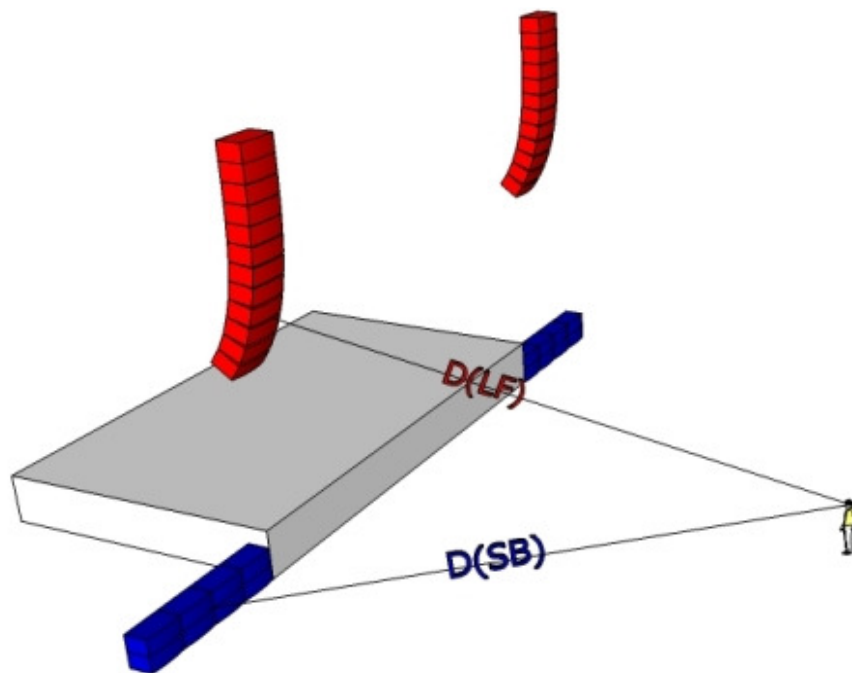

Figure 12. Distances to Main and Subwoofer

Convert this sound to a delay time, considering that sound takes about 0.9 mSec per foot, or 3 mSec per meter, This number is an estimate of the delay time required.

**If you have limited setup time, you can simply enter the delay estimate into the crossover and omit the rest of the tuning process.** The delay should be applied to whichever cluster (main or subwoofer) is *nearest* the listening point. If you want a more precise result, follow the steps below.

8. Set the generator frequency *equal* to the crossover frequency. Unmute both main and subwoofer clusters. If you're tuning a left-right system, unmute only the side you're using for tuning.
9. Set the delay to the estimated value, as described in step 7 above.
10. Adjust the delay up and down for maximum loudness at the listening point. You can use your ears or an SPL meter or a measurement system or any microphone and VU meter for this step.
  - If you end up with a delay value that's more than 10-15 mSec different from your estimate, then either the estimate is wrong or the venue is pathological. In this case, just use the estimated value and omit any further steps.
  - If you chose the Linkwitz-Riley crossover type in step 3, then you're done.
  - If you chose the Butterworth crossover type in step 3, then proceed to step 11.
11. (Butterworth crossovers only). Apply the *Butterworth Tweak*. Increase or decrease the delay by the following amount:

Crossover freq	Tweak (mSec)
70	3.57
80	3.13
90	2.78
100	2.50

The rule about whether to increase or decrease the delay is a bit complicated. The best procedure is to try both and choose whichever gives the best coverage.

## Appendix B: Subbass Equalization

Some mix engineers like to use systems with built-in bass boosts. Here, for example, is a curve used in stadiums and arenas by well-known male vocalist with whom the author is familiar:

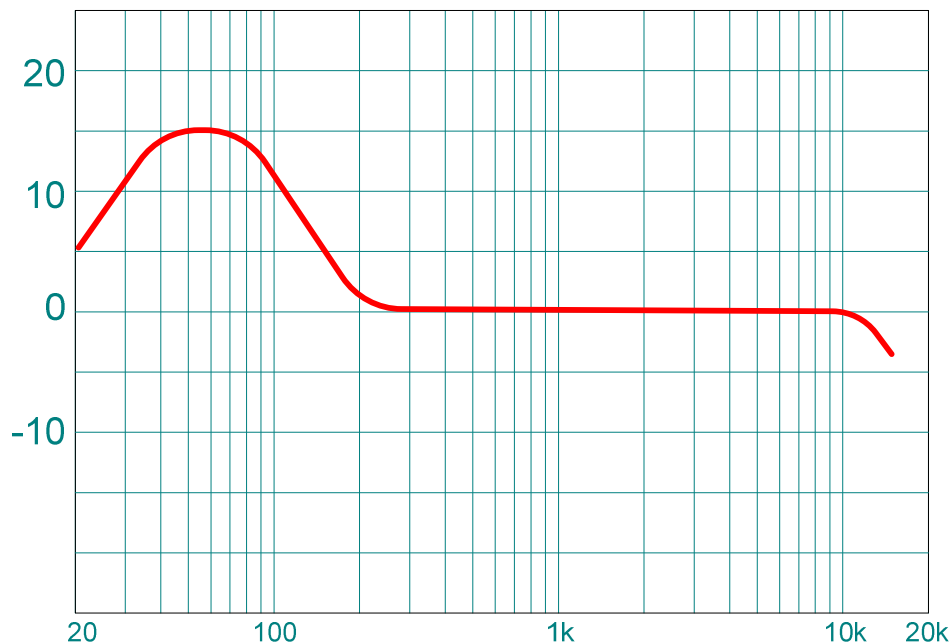

**Figure 35. System bass boost**

To achieve frequency response curves like these, it is traditional to increase the gain of the subwoofer channel. The problem with this practice is that changing the gain of subwoofers only can affect the behavior of the subwoofer crossover in unexpected ways.

A better practice is to tune the subwoofer crossover to give a flat response (as described above in Appendix B), then to use equalization (we call it “subbass contour EQ”) to create the desired overall curve. This equalization will not interfere with the subwoofer crossover **as long as it is applied equally to both the subwoofers and the main array.**

This principle leads to one of two signal path diagrams, depending on whether the subwoofers are driven as part of the main mix or from their own mix.

Figure 36 shows the case in which the subwoofers are driven from the main mix. The subbass contour EQ is configured as a normal pre-crossover equalizer.

Figure 37 shows the case in which the subwoofers are driven from a separate mix. In this case, subbass contour EQ is implemented by a pair of equalizers, one on each mix. Both equalizers should always have the same setting. This can be done manually, or by using a multichannel equalizer, or, in the case of software-controlled equalizers, but linking channels in software.



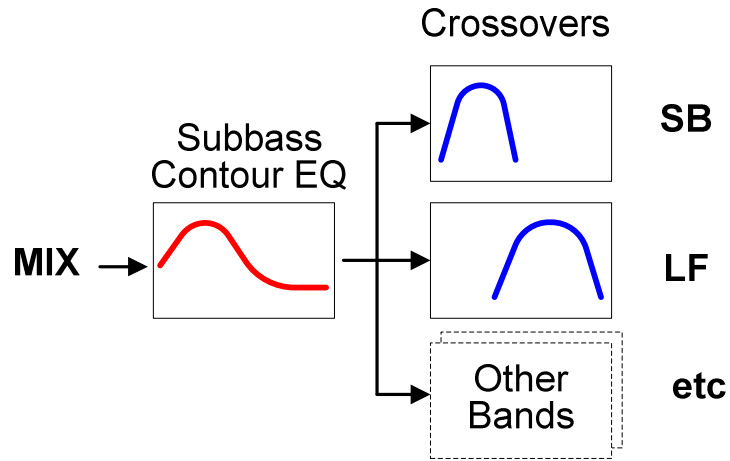

Figure 36. Subbass contour EQ, subwoofers driven from main mix.

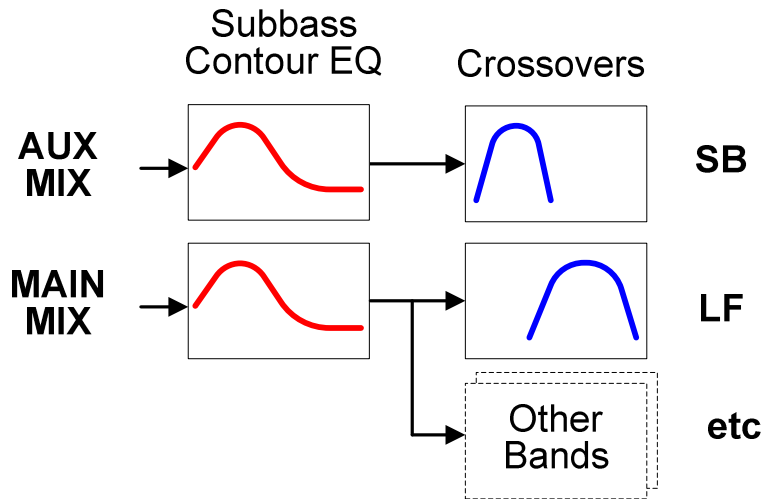

Figure 37. Subbass contour EQ, subwoofers driven from an aux mix.

## Appendix C: Distortion Beaming

If you do the math (or use a modeling program to do it), it will tell you that a single subwoofer box is essentially omnidirectional in its working frequency range. This means that you should hear the same sound from all sides of the box.

Many audio specialists find this result difficult to believe, because their ears have told them differently in practice. What is going on?

The discrepancy arises because all loudspeakers have some distortion. They generate higher-frequency harmonics. The box is omnidirectional at the fundamental frequency, but directional at the harmonic frequencies.

Figure 38 shows the directivity of a single EV Xsub (or any similar-sized box) at 90Hz, 180Hz (the second harmonic of 90), and 270 Hz (the third harmonic of 90). The effect is clear: the fundamental is radiated in all directions, but the distortion emerges as a frontal beam.

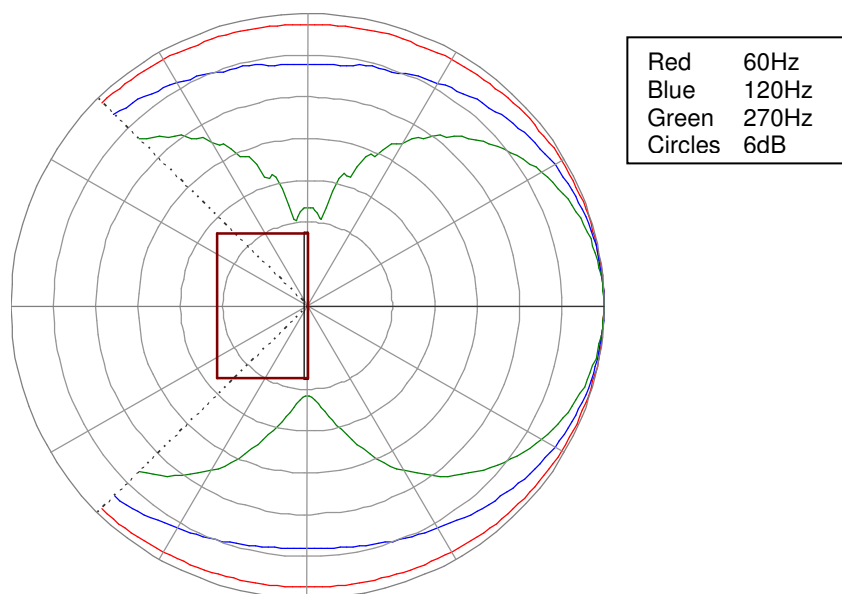

**Figure 38. Directivity of single subwoofer at 90, 180, and 270 Hz.**

At normal listening levels the ear is much more sensitive at the harmonic frequencies than at the fundamental frequency. Thus, even though the levels of distortion harmonics will be small for low-distortion woofers, they will effectively be amplified by the ear. Ears are good at identifying sounds by their harmonics. Hence, the ear hears the harmonics beaming out the front of the box, and concludes that the fundamental is a beam as well.

For high-distortion woofers, distortion beaming can be quite obnoxious. In one case known to the author, a tour reconfigured its subwoofer stacks (*not* EV loudspeakers) specifically to avoid subjecting narrow sections of the audience to intense distortion products.

---

**Bosch Communications Systems**

---

**Americas****Headquarters Americas**

Bosch Security Systems, Inc.  
12000 Portland Ave South,  
Burnsville, MN 55337, USA  
Phone: 1 800 392 3497  
Fax: 1 800 955 6831

**Canada**

Phone: 1 866 505 5551  
Fax: +1 866 336 8467

**Latin America**

Phone: 1 952 887 5532  
Fax: 1 952 736 4212

**EMEA****Headquarters Europe,  
Middle East & Africa**

Bosch Sicherheitssysteme GmbH  
Robert-Koch-Strasse 100  
85521 Ottobrunn, Germany

**Contact & Visitor Address**

EVI Audio GmbH  
Sachsenring 60  
94315 Straubing, Germany  
Phone: +49 9421 706 0  
Fax: +49 9421 706 265

**France**

EVI Audio France S.A.S  
Phone: +33 1 6480 0090  
Fax: +33 1 6006 5103

**Middle East**

Robert Bosch Middle East FZE  
Phone: +97 14 212 3300  
Fax: +97 14 212 3388

**Asia & Pacific****Headquarters APR**

Robert Bosch (SEA) Pte Ltd  
38 C Jalan Pemimpin  
Singapore 577180  
Phone: +65 6319 0616  
Fax: +65 6319 0620

**Australia**

Bosch Security Systems Pty Ltd  
Phone: +61 2 9683 4752  
Fax: +61 2 9890 5928

**China**

Telex EVI Audio  
(Shanghai) Co., Ltd.  
Phone: +86 21 6317 2155  
Fax: +86 21 6317 3025

**India**

Bosch Limited  
Phone: +91 80 4176 8378  
Fax: +91 80 4176 8263

**Japan**

EVI Audio Japan  
Phone: +81 3 5485 4427  
Fax: +81 3 5485 4428

**Thailand**

Robert Bosch Limited  
Phone: +662 639 3111  
Fax: +662 631 2030

**Korea**

Robert Bosch Korea  
Phone: +82 31 270 4765  
Fax: +82 31 270 46

